

CREDA RF PANEL HEATERS

Models Covered:

400 mm High

**85510 (800W) RF/E408
85520 (1000W) RF/E410
85530 (1200W) RF/E412
85540 (1500W) RF/E415
85550 (2000W) RF/E420**

200 mm High

**85610 (800W) RF/E208
85620 (1000W) RF/E210
85630 (1200W) RF/E212
85640 (1500W) RF/E215**

400 mm High - IP24

**85820 (600W) RF/E406S
85840 (1000W) RF/E410S**

Service Information

SAFETY NOTES & GENERAL SERVICING ADVICE

1. This Manual is **NOT** intended as a comprehensive repair/maintenance guide to the appliance. It should **ONLY** be used by suitably qualified persons having technical competence, applicable product knowledge, and suitable tools and tests equipment.
2. If you are in the slightest doubt we strongly recommend that you contact your installer or contact Applied Energy Products Ltd. - Technical Help Desk (Tel. 08709 000430).
3. For all other customers, consult your local distributor or other authorised service agent.
4. Earth Continuity and Insulation Resistance checks **must** precede servicing.
5. **The heater must be connected to fixed wiring via a double pole isolating switch having a contact separation of 3 mm in each pole and in accordance with I.E.E. regulations currently in force and in accordance with any local code of practice.**
6. **It can be dangerous to attempt 'DIY' repairs/maintenance on complex equipment and the Company recommends that any problem with the appliance is referred to its own Service Organisation.**
7. **WARNING:**
ALWAYS ISOLATE THE HEATER FROM THE ELECTRICAL SUPPLY/SUPPLIES before undertaking any maintenance work. As the heater may have more than one electrical feed to the unit, it is essential to ensure that all electrical supplies are isolated from the heater.
8. Personal safety precautions must be taken to protect against accidents caused by sharp edges on metal and plastic parts.
9. **Genuine Creda spare parts should always be used.**
10. The mains lead is specially produced by Creda. In the event of damage, a replacement should be ordered from Creda and installed by a qualified electrician. We therefore strongly recommend that you contact your installer or Applied Energy Products Ltd. - Technical Help Desk (Tel.: 08709 000430).
11. **WARNING:**
The surface temperatures of this heater are within the requirements of the EU directives. However, the temperatures are sufficiently high to cause scald injury to bare flesh. Aged or infirm persons or young children should not be left unsupervised in the vicinity of the heater, unless a suitable guard is fitted.
12. The heater should not be mounted directly below an electric outlet.
13. Vinyl floor coverings and varnished floors require a minimum clearance of 120 mm to the underside of the heater.
14. After servicing the appliance must be rechecked for electrical safety.

Originator - E. Arnold, Service Technical Engineer

INDEX

Safety Notes & General Servicing Advice	2
Introduction	3
Technical Specification	4 - 5
Safety in Use	5
Installation	6 - 7
Wiring Diagram	7
Setting The Controls	8
CredaSaver	9 - 11
RF Receiver	12
Installing & Setting the Credazone Controller	13 - 16
Quick Reference Chart for Fault Diagnosis	17
Dismantling Procedure	18 - 19

INTRODUCTION

These heaters were introduced into the Creda range in September 2001 and have a 1 year guarantee period.

The servicing period of these products began in March 2003.

All Panels are electric Panel Convector with integral adjustable thermostats.

The thumb wheel thermostats are adjustable between 5°C to 30°C and positioned on the top right side facia. These thermostatic heaters can also be controlled by a remote non-wire radio frequency transmitter (CredaZone1 or 4) with the Receiver or plug-in (85711).

A timer control plug-in (85712) is also available.

All panels include a double pole on/off switch, with a contact separation gap of 3 mm situated on the lower right hand side of the heater and an electrical 4 core cable is fitted as standard.

Position of Rating Plate

The Rating Plate is positioned on the top right hand side of the heater, immediately behind the 'Do Not Cover' legend.

TECHNICAL SPECIFICATION

Weekly programmable

A single CredaZone controller can control several RF Panels

Radio communication 433 MHz

Range 35m (free sight)

Meets requirements of the EUs low voltage directive (73/23EEC) and directive concerning electromagnetic compatibility (89/31/EEC).

Thermostatic control

Frost protection 5 - 15°C

Setback temperature 5 - 30°C

Comfort temperature 5 - 30°C

Model No.	Code	Rating (W)	Supply Single Phase AC	Current (amps)	Width (mm)	Height (mm)	Depth (mm)	Fixing Centres (mm)	Other
85510	RF/E408	800	230-240V	3.5	645	400	80	370	
85520	RF/E410	1000	230-240V	4.3	735	400	80	460	
85530	RF/E412	1200	230-240V	5.4	915	400	80	640	
85540	RF/E415	1500	230-240V	6.5	1095	400	80	820	
85550	RF/E420	2000	230-240V	8.7	1365	400	80	1090	
85610	RF/E208	800	230-240V	3.5	1095	200	80	820	
85620	RF/E210	1000	230-240V	4.3	1275	200	80	1000	
85630	RF/E212	1200	230-240V	5.4	1545	200	80	1270	
85640	RF/E215	1500	230-240V	6.5	1725	200	80	1450	
85820	RF/E406S	600	230-240V	2.6	555	400	80	280	*
85840	RF/E410S	1000	230-240V	4.3	735	400	80	460	*

* Splash proof version suitable for use in bathrooms. IP24C. Incorporates a splash proof cover with Manual reset.

CONTROLLERS

Model No.	Description	Method
85710	CredaZone 4 RF Controller	Hand held / Wall Mounting
85711	Plug-in Receiver	Plug-in
85712	Plug-in Creda Saver	Plug-in
85715	CredaZone 1 RF Controller	Hand held / Wall Mounting
85713	Covers for Controls	

OPTIONAL CONTROLLERS (Not supplied)

- **CredaZone 1 or 4**
Remote controller requires 3 x AAA 1.5V alkaline batteries. (Battery lifetime 2 years.)
Hand held or wall mounted.
Note: - Requires CredaZone Receivers.
- **CredaZone Receiver**
Plug-in cartridge with integral thermostat back-up.
Note: - Requires CredaZone 1 or 4 Controllers.
- **Creda Saver**
Plug-in pre-programme cartridge.
15 preset programmes which can be adjusted to suit (Day/Hour).
Economy mode thermostat on Creda Saver.
- **Covers**
Cover to prevent unwanted heater operation.
This is in 2 parts for the thermostat knob and the on/off switch (Contact supplier).

SAFETY IN USE

DO NOT spill liquids onto the appliance. If you do, switch the heater **OFF** and get a qualified electrician to check it.

When young children, elderly or infirm people are present, the appliance should be adequately guarded.

DO NOT poke objects through the grille ventilation slots or any other apertures in the heater casing.
DO NOT use polishes on the heater or on furniture near to it.

If you are the householder, **DO NOT** attempt to repair it yourself. In case of breakdown or other failure, switch off the heater at the wall switch and consult your supplier, local electricity supplier or Applied Energy Products Ltd. Always ensure that the heater is switched off at the wall switch and the fuse removed before any repair is carried out.

The mains lead is specially produced by Creda. In the event of damage, a replacement should be ordered from Creda and installed by a qualified electrician.

INSTALLATION

Before drilling walls to fit the wall brackets, check that there are no cables or pipes buried in the wall. Wall fixings must be appropriate for the construction of the wall. The heater should be mounted horizontally and not be mounted directly below an electric outlet. Position the heater to avoid curtains etc. being within 100 mm (4") around the top and ends of the heater. Vinyl floor coverings and varnished floors require a minimum clearance of 120 mm to the underside of the heater.

Heater types 85820 and 85840 are suitable for use in bathrooms or shower rooms. For these installations the heater must be positioned so that a person in the bath or shower cannot touch switches and other controls.

Ensure that all packaging material is removed from the heater.

1. Fix the wall bracket to the wall, allowing for the minimum clearance requirement (listed in the tables below). The wall bracket may also serve as a template (see drawing). Please ensure the wall bracket(s) is positioned in accordance with the drawing.
2. Align the bottom of the heater onto the bottom hooks of the wall bracket. Raise the heater towards an upright position and secure the wall bracket safety strap(s), before finally securing the heater to the top wall brackets.

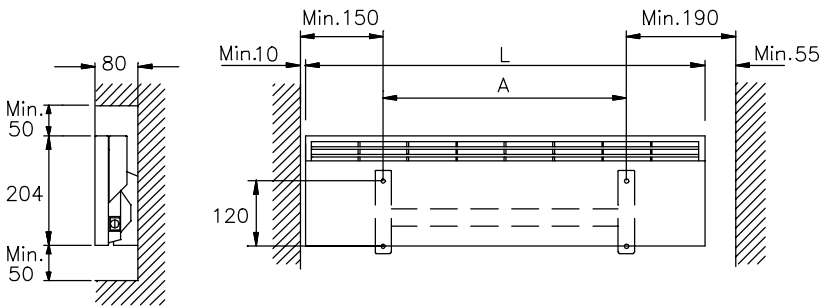

Cat. No.	Watts	L	A
85610	800W	1095	820
85620	1000W	1275	1000
85630	1200W	1545	1270
85640	1500W	1725	1450

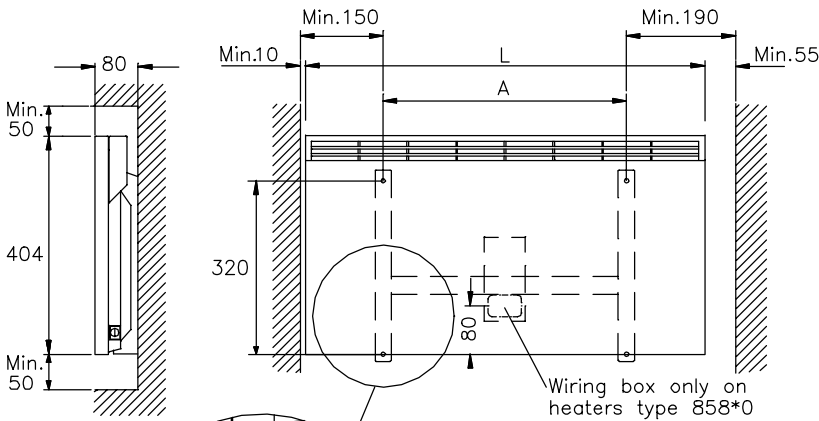

Cat.No	Watts	L	A
85510	800W	645	370
85520	1000W	735	460
85530	1200W	915	640
85540	1500W	1095	820
85550	2000W	1365	1090

Cat.No	Watts	L	A
85820	600W	555	280
85840	1000W	735	460

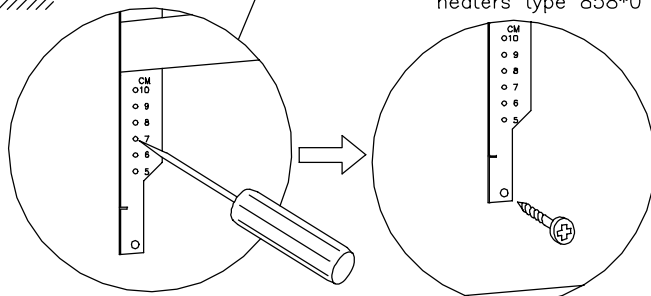

Fig. 1
Mounting Positions

CONNECTING THE HEATER TO THE MAINS

All heaters incorporate a 4 core mains cable.

The heater must be connected to fixed wiring via a double pole isolating switch having a contact separation of 3 mm in each pole and in accordance with I.E.E. regulations currently in force and in accordance with any local code of practice.

GREEN & YELLOW	EARTH
BLUE	NEUTRAL
BROWN	LIVE
BLACK	CONTROL CABLE LIVE (Pilot Wire)

Note: - The Live Black Pilot wire allows a 5° night set-back which can be controlled by a remote timer and must be disconnected before service.

If the Night Set Back Control is not required, the Black control cable can be ignored, however, the cable must be made safe within the appliance. Refer to Night Set Back Control below.

NIGHT SET BACK CONTROL

The heater has an in-built temperature reduction function that is designed to be controlled by a remote central controller (time switch). When the controller sends a signal (230 - 240V applied) via the control cable, the thermostat will reduce the room temperature by approximately 4°C in relation to the set temperature.

SCHEMATIC WIRING DIAGRAM

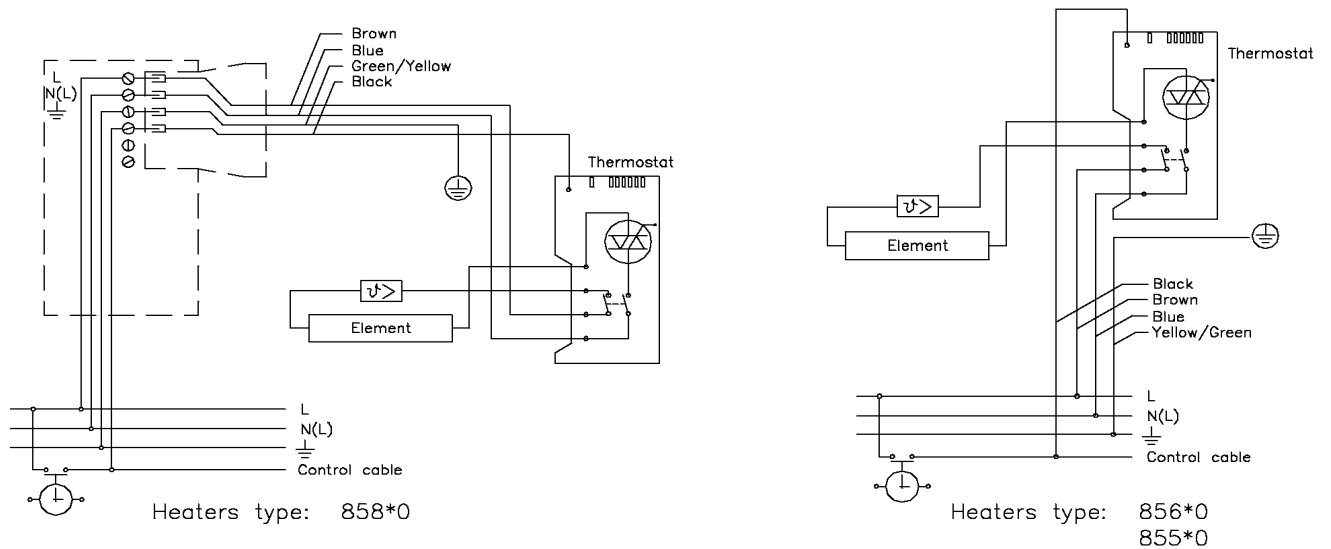
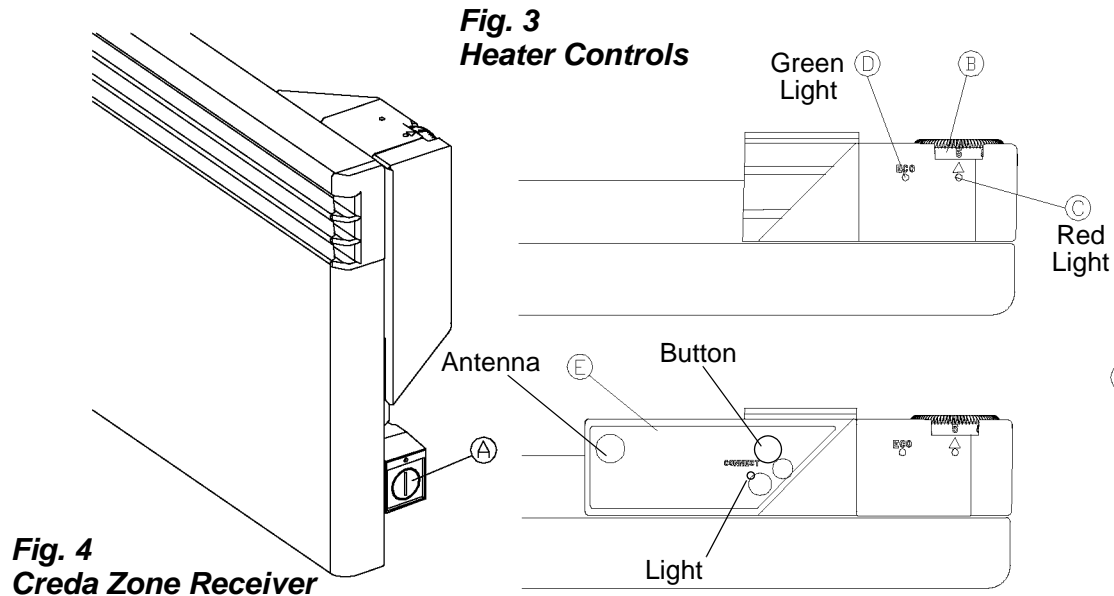

Fig. 2

SETTING THE CONTROLS

Ensure that the appliance is securely fixed to the wall with the correct electrical connections made. Switch on the heater by pressing the switch **A**, and turn the thermostat dial (**B**) to 30 (max.). Red LED **C** should come on, indicating that the heater is on and working. When the required room temperature is reached, slowly turn the thermostat dial **B** backwards from the 30 until the light **C** goes out. The minimum setting 5 offers frost protection.



Warning - the surface of the heater can be hot

Commissioning Period

NOTE! The internal element(s) have a protective oil covering. This will evaporate when the heater is switched on for the first time and may emit a harmless smoke for the first few minutes. Rooms must be well ventilated during the commissioning period.

SAFETY DEVICE

The heater has a built-in safety device, which disconnects the power, if for example, the heater is accidentally covered. The item(s) covering the heater must be immediately removed!

NOTE: The safety device will automatically reconnect the power supply as soon as the temperature in the heater returns to normal (excluding 85820 and 85840).

Heater models 85820 and 85840 have an integral manual re-set cut-out.

As soon as the temperature in the heater returns to normal, lift and tilt the heater forward and press the red button on the rear of the heater. The electrical supply will be restored to the heater.

CREDASAVER CREDA PLUG-IN CONTROL MODULE (Optional)

- C = Mode Button
- D = Set / Pause Button
- E = Display
- F = Selected Mode Indicators
- G = Thermostat Knob

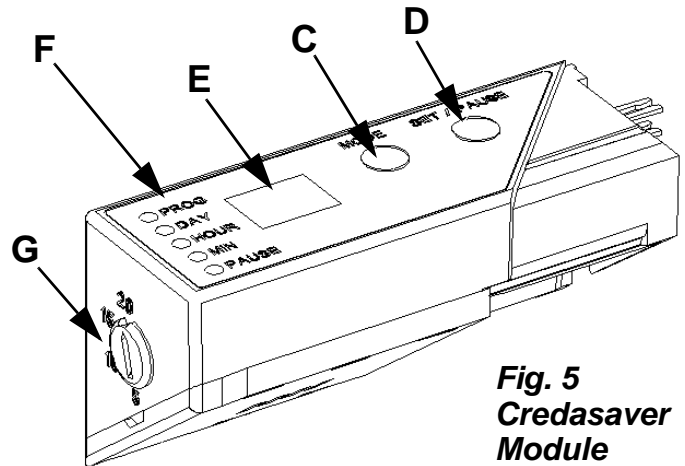

Fig. 5
Credasaver
Module

1. Description

The **CREDASAVER** is a timed control, which can be plugged into all Creda thermostat heaters, type 85**0.

It gives you the ability to control the heater with up to 15 pre-defined programmes.

In the **Comfort Mode**, the heater will be regulated according to the temperature chosen with the heater thermostat knob indicated by red light (C) Fig. 3.

In the **Economy Mode**, the temperature will be regulated according to the position of the thermostat knob (located on the side) on the CREDASAVER plug-in unit.

When in the Economy Mode, the Green LED (D) Fig. 3 on the heater will be on.

Note: - For the controller to operate you MUST programme the present date and time.

2. Installation

1. **Switch off the heater.**
2. Plug-in the CREDASAVER into the left-hand side of the thermostat housing.
3. Adjust the thermostat knob (B) Fig. 3 on the heater to the desired comfort temperature.
4. Adjust the thermostat knob (G) Fig. 5 on the CREDASAVER to the desired Setback Temperature.
5. Switch on the heater. Wait until the display (E) Fig. 5 appears with two horizontal lines.

When installed for the first time or after a prolonged period of power failure, the Creda Saver will lose its settings. This is indicated by the display (E) Fig. 5 showing two horizontal lines.

3. Choice of Programme & Adjustment of Hour / Day

This is done by means of the two keys on the CREDASAVER.

The MODE-key (C) Fig. 5 is used for choosing adjustment mode, e.g Programme Day, Hour and Minutes.

The SET/PAUSE- key (D) Fig. 5 is used for altering the settings within each mode.

4. To Start

1. Press the MODE key once. The PROG red LED (F) Fig. 5 will light up with the first programme 'P0'.
2. Choose a programme by pressing the SET/PAUSE key until the desired programme comes up.

3. The 15 defined pre-programmes will be indicated as P0, P1, ..., P9, E1, E2, ..., E5 in the display. Refer to the programme chart below and select one pre-programmed to suit the end user.
4. Press the MODE key once more. The DAY (F) LED will light up and indicate that a weekday may be chosen.
5. Press the SET/PAUSE key to choose one of the pre-programme profiles for the weekday. 1 is Monday, 2 is Tuesday, .., 7 is Sunday.
6. Press the MODE key once more, and the LED marked HOUR will light up. The correct hour may be chosen.
7. Press the MODE key once more. Now the LED marked MIN will light up, and the minutes can be adjusted.
8. After approximately 20 seconds the CREDASAVER returns to its normal operating mode and all settings are stored.

5. Cancellation of Setback Period

1. A setback period can be cancelled by pressing the SET/PAUSE key when the CREDASAVER is in its normal operating mode.

NOTE: - In the normal operating mode, none of the 5 red LEDs will be illuminated.

The present or first setback period will then be cancelled. To suspend the cancellation, the SET/PAUSE key may be pressed once more.

CREDASAVER QUICK PROGRAMME GUIDE

Fig. 6
Quick Setting Guide - Credasaver

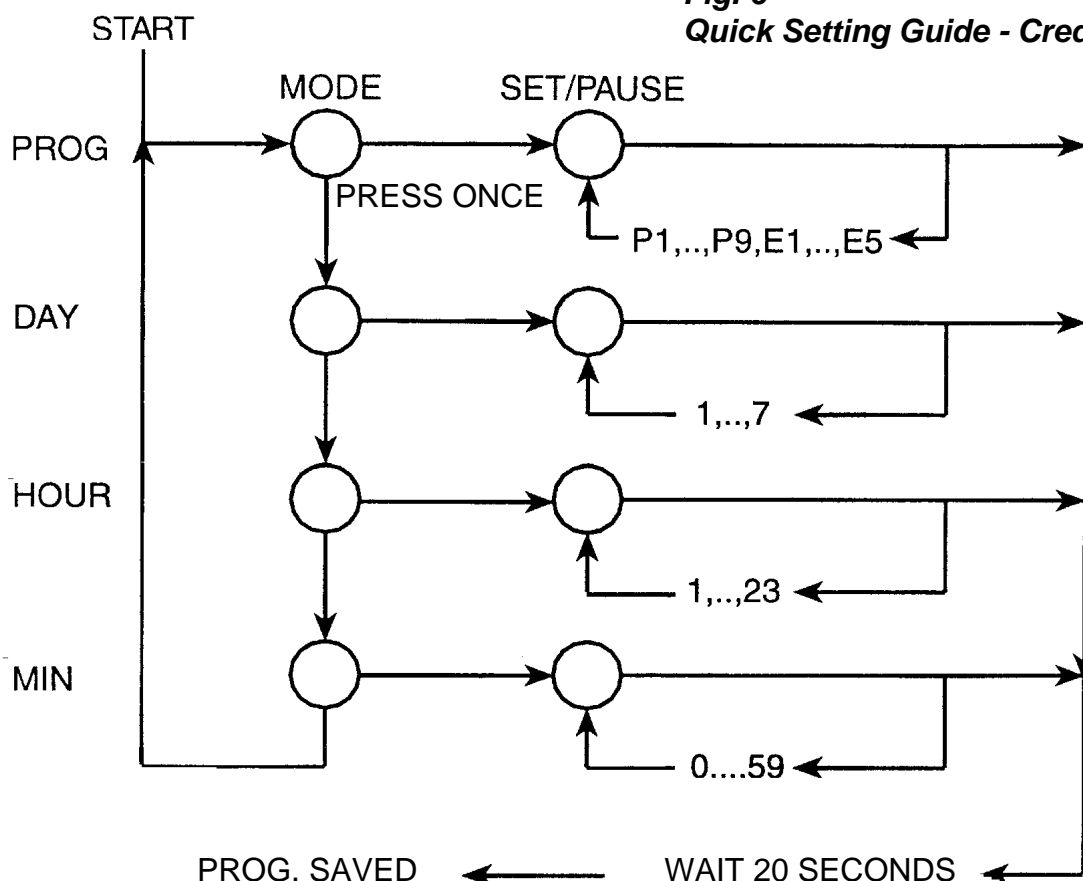

PROGRAMME HEATING PROFILES

Fig. 7

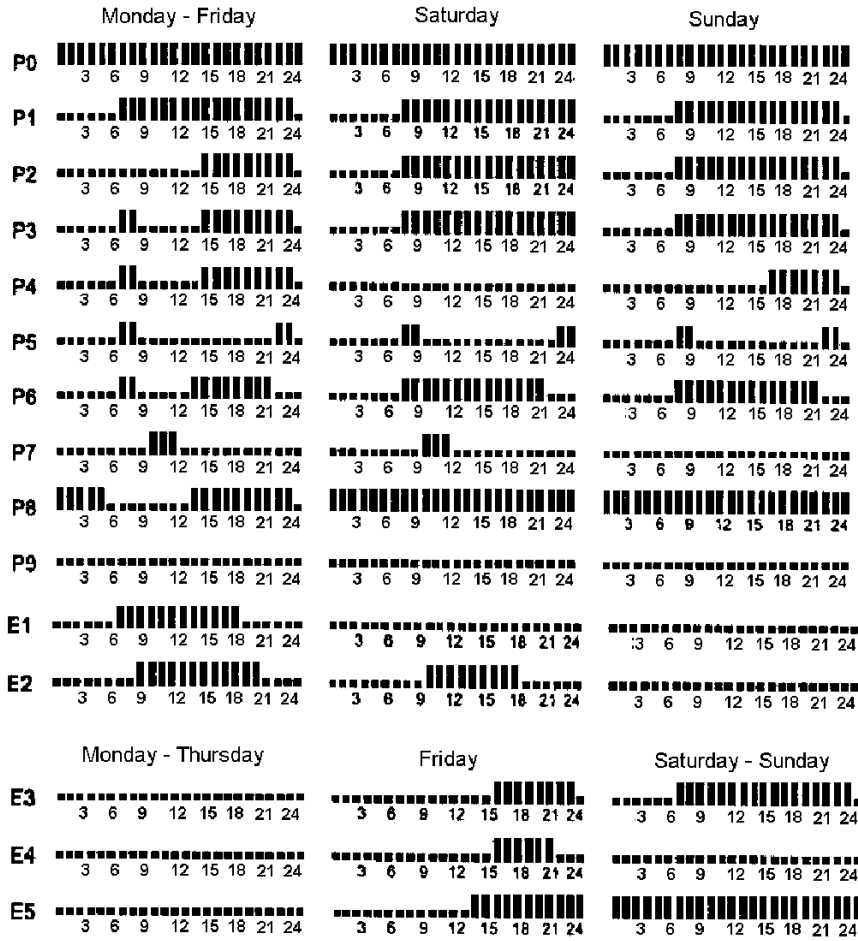

RF RECEIVER

CREDAZONE PLUG-IN CONTROL MODULE

1. Description

The following RF Receiver plug-in module will operate Creda Panel heater types 855*0, 856*0 and 858*0 with thermostat control and must be controlled by one of the following central controllers: - CredaZone 1 or CredaZone 4.

2. RF Receiver First Time Installation

a. Switch the heater off.

b. Insert the RF Receiver into the left hand side of the thermostat on the upper right hand side of the heater.

c. Set the thermostat wheel (**B**) to the to desired temperature.

NOTE: - Should the RF Receiver fail the desired temperature will be maintained.

d. Switch on the heater.

e. After a few seconds, the RF Receiver CONNECT (**L**) LED will light continuously.

f. Set the central unit (CredaZone1 or CredaZone4) to its configuration mode. 

g. Press and hold the '+' button for 3 to 5 seconds and the configuration mode **CnF** will be displayed.

h. Press RF Receiver '+' button again until the **CnF** display is replaced by '- - -'.

i. The selected configuration will only begin when the **Auto** position is selected.

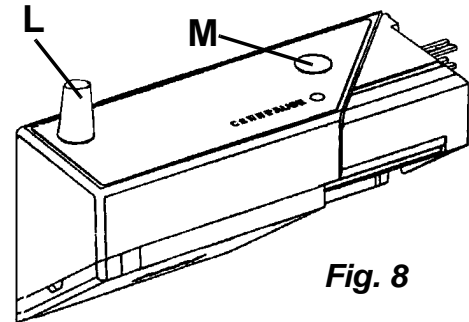



Fig. 8

3. Testing for Correct Configuration

a. Set the central unit controller CredaZone1 or CredaZone 4) to the configuration mode .

b. From the '- - -' display, press the - (minus) button on the CredaZone controller until the script '**tEst**' is displayed.

c. At this stage the RF Receiver will begin with 3 flashes for every 3 seconds.

d. Press the CredaZone controller - (minus) button to display '- - -'.

e. Switch the CredaZone controller to the **Auto** select position.

f. The test procedure is now complete and the Credazone controller will now control the heater.

Note: - In the case of electrical power failure it will be necessary to reconfigure all RF Receivers.

Reconfiguration

1. Set the central unit controller (CredaZone1 or CredaZone4) to the configuration mode .

2. Press the button (**M**) on the RF Receiver and hold it for approximately 10 seconds until the CONNECT LED starts flashing.

3. Press the key once more and after a few seconds it will light continuously.

4. Close the configuration mode on the central CredaZone1 or CredaZone4 unit to **Auto**.

5. The CredaZone1 or 4 central unit will now control the heater.

Notes:

During normal operation the CredaZone central unit will control the heater.

Should the radio communication fail, the RF Receiver will switch to the room temperature indicated by the thermostat wheel (**B**). In this case the CONNECT LED will start flashing.

When the radio communication is restored, the central controller will automatically start operating again.

INSTALLING & SETTING THE CREDAZONE CONTROLLER

The following information is taken from the user instructions for the controller.

CredaZone1

1. Description

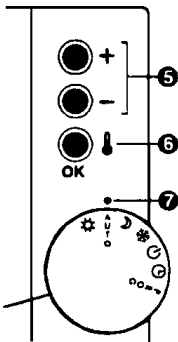
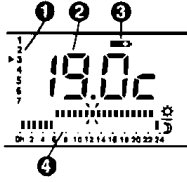

- 1) Current day
1 is Monday,
2 is Tuesday, etc.
- 2) Temperature display
- 3) Low battery indicator
- 4) Program profile
- 5) Modification keys
- 6) Measured temperature display or validation in programming mode
- 7) Operating mode selector

CredaZone4

1. Description

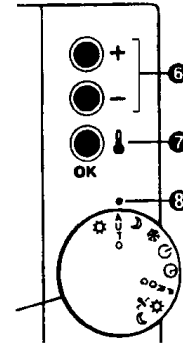
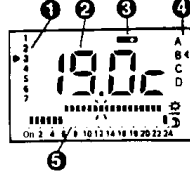

- 1) Current day
1 is Monday,
2 is Tuesday etc.
- 2) Temperature display
- 3) Low battery indicator
- 4) Zone indicator
- 5) Program profile
- 6) Modification keys
- 7) Verification in programming mode
- 8) Operating mode selector

2. Installation

The control unit must be positioned correctly. The recommended height is 1.5m in an accessible place, away from heat sources (fireplace, sunlight) and draughts (window, door).

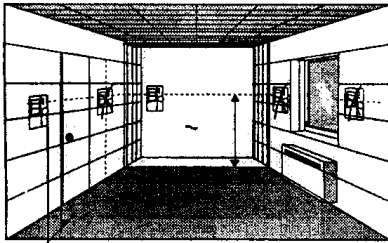

Min 20 cm

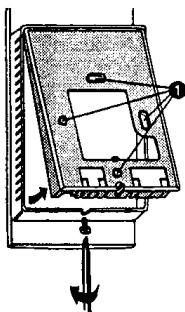

To install, remove the cover on the rear of the unit.

The cover is mounted on the wall by means of screws (c/c-distance 60 mm.) Fit the unit onto the cover.

3. Installing the batteries

The unit utilises 3 x LR03 or AAA 1,5 V alkaline batteries.

Do not use rechargeable batteries

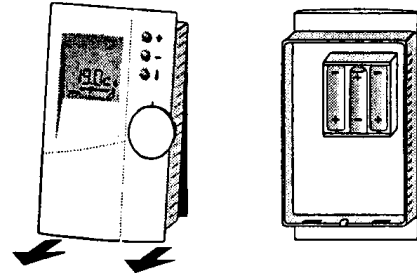

Remove the unit and install the batteries as shown on the illustration. Ensure that the batteries are turned the correct way. Mount the unit back on the wall bracket.

Change of batteries.

When the battery indicator  appears in the display, the batteries should be changed as soon as possible.

All the programmed information is stored during battery change (approx. 1 min.)

CLOCK SETTING THE CREDAZONE1 & CREDAZONE4

Press the  key and the value of the room temperature is displayed.

CLOCK ADJUSTMENT



Set the mode selector to 

Set the correct hour by pressing  or 

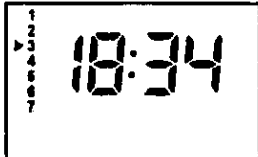

By passing the 24.00 Hrs, the following day will display.

Quick pressing of the keys gives 1 minute steps.

Press and hold gives fast change.

Remember: 1 = Monday; 2 = Tuesday; 7 = Sunday

CONGIFURATION CREDAZONE1

Note: -

Before the system can be controlled by the CredaZone, all Creda RF Receivers MUST first be configured. Refer to RF Receiver First Time Installation and Configuration.

- Should more than one controller be used, the configuring decides which receiver is to be controlled by which control unit.
- Take the CredaZone controller to each heater or ensure the controller is within range of the heaters and begin configuring each heater.
- Set the controller (CredaZone1 or CredaZone4) to the configuration mode .
- Press and hold the + button for 3 to 5 seconds until the configuration mode CnF is displayed.
- Press the RF Receiver + button again until the CnF display is replaced by '- -'.
- Set the CredaZone controller to the 'Auto' setting.

TEMPERATURE SETTINGS ON THE CREDAZONE1

Setting the Comfort Temperature



The Comfort temperature setting will be the temperature when the room is occupied.

The Comfort temperature setting ranges between 5°C and 30°C.

Set the Comfort temperature and record in the temperature box below.



Switch the selector to 

 or  set the temperature

Also gives permanent comfort temperature * Insert temperature required.

*Temperature = °C



Note: The Comfort temperature must be above the room temperature for the panel heater(s) to switch on to the heating mode.

The CredaSaver Red neon will light to indicate when the RF Panel Heater is switched to the heating mode.

Setting Frost Protection Temperature



Switch the selector to 



 or  set the temperature

 Also gives permanent frost-protection

Setting the Set-Back Temperature



Switch the selector to 

 or  set the temperature

Also gives permanent set-back temperature

PROGRAMMING THE CREDAZONE CONTROLLER

Week Programming



Modifying and validating your program

Switch the selector to PROG

Choose the right zone with **OK**.
No temperature is displayed and you can see the program for the first day. The first time slot flashes.

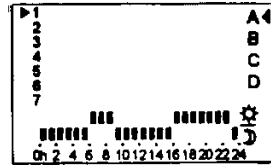

Press **+** for 1 hour of comfort or **-** for 1 hour of set-back temperature (the second time slot flashes).
Repeat the same procedure for each time slot.

When the day-program has the desired profile, press **OK** and the profile is stored. The next day comes up.

Repeat the same procedure for each day and for all zones A –D.



When you have done your programming, switch the selector to AUTO to run your weekly program.

By pressing **OK** you may choose the zone for which the program status shall be displayed.

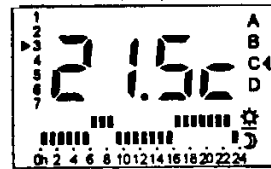

Set the mode selector in this position, and set-back temperatures are set for all zones. By pressing **OK** you may choose which zone the temperature displays.



With the mode selector in this position, comfort temperatures in all zones are chosen.



With the mode selector in this position, comfort temperatures in all zones are chosen.

By pressing **OK** you may choose which zone the temperature displays.

QUICK REFERENCE CHART FOR FAULT DIAGNOSIS

Heater is cold	Safety Cut-out operated Thermostat or controller set too low Heater switched off either at heater switch, local isolator or consumer unit Bad wiring connection Supply failure	Reset Adjust settings Check and switch on Check wiring Check electrical supply
Poor heat output	Settings on thermostat or controller. Heating element failure Faulty thermostat	Increase temperature settings Check / replace Check / replace
Two flashing horizontal lines appear on the Creda Saver plug-in timer	When installed for the first time or after a prolonged period of power failure, the CREDASAVER will lose its settings. This is indicated by the display (E) showing to horizontal lines	Re-programme
CONNECT LED is flashing on the Receiver	Radio communication failure	Check Creda Zone controller / reset. Ensure that the Receiver is correctly inserted.
Creda Zone controller battery indicator is on	Faulty or missing batteries	Check / replace
Safety cut-out operated	Clothing draped over heater Restricted air circulation around heater Faulty thermostat	Check and remove obstructions

DISMANTLING PROCEDURE

ALWAYS ISOLATE THE HEATER FROM THE ELECTRICAL SUPPLY/SUPPLIES before undertaking any maintenance work. As Tele-switching of off peak supplies becomes more common, and the times at which off peak supplies are available varies, it is essential that the off peak consumer unit as well as the adjacent isolator switch are both switched off prior to servicing the heater.

A. FRONT PANEL

1. To remove the front panel, release the screws along the bottom edge of the front panel.
2. Pull the bottom edge of the front panel forwards and lift the top flange away from the top lip of the rear cover. Put the front cover in a safe place to prevent damage.

B. HEATING ELEMENT

WARNING: - Allow the heater sufficient time to cool down before any attempt is made to remove the element.

1. Release the Live and Neutral connections from each end of the straight length, heating element.
2. Using suitable long nosed pliers bend back the 4 retaining tags at each end of the element.
3. Lift the element away from the heater.
4. Fit the new element, ensuring adequate electrical clearance between the terminals and the outer casing and/or the PCB.
5. Straighten the 4 retaining tags to secure the element.

IMPORTANT: The retaining tags provide electrical bonding of the element sheath to the main Earth connection. It is vital that these tags securely grip the element. After changing an element check the resistance between the element sheath and the earth terminal. Resistance must be less than 0.5Ω .

6. Reconnect the cables to the element terminals. Ensure the push on connections securely grip the element terminal pin.
7. Refit the front cover and the retaining screws. Ensure the screws are securely tightened as they provide the earth bonding for the front panel.

C. WALL BRACKET

1. To replace the wall bracket, firstly lift the heater upwards, then pull the top of the unit away from its location.
2. Release the white plastic restraining strap(s) from the rear of the heater and lift the complete unit away from the bracket.
3. Remove the bracket from the wall.
4. Fit the new bracket securely to the wall.
5. Enter the heater on the hooks at the bottom of the wall bracket. Rise the heater towards an upright position, fasten the strap(s) and fasten the heater on the top of the wall brackets.

D. OVERHEAT THERMOSTAT

WARNING: Allow the heater sufficient time to cool down, before any attempt is made to replace the thermostat.

The heater must be isolated from the electricity supply before changing the thermostat.

1. Remove the front cover as described earlier.

2. Prise the 2 plastic, thermostat-securing lugs apart, and lift the thermostat from the plastic bracket. Note the orientation of the thermostat to ensure new unit is fitted back in the same way.
3. Remove the 2 terminals from the old thermostat and fit the new unit in the same way. If enhanced access is required the plastic housing can be removed by pulling the top edge towards you, and twisting the housing anti-clockwise through 45°. The housing can now be pulled from the heater.
4. Refitting is a reverse of the removal procedure.

**For spare parts contact:
Applied Energy Products Ltd.
National Spares Line:
08700-102829**